

Canon

MEDLIGA
медицинское оборудование



Aquilion ONE

PRISM Edition

Deep Intelligence

medliga.ru

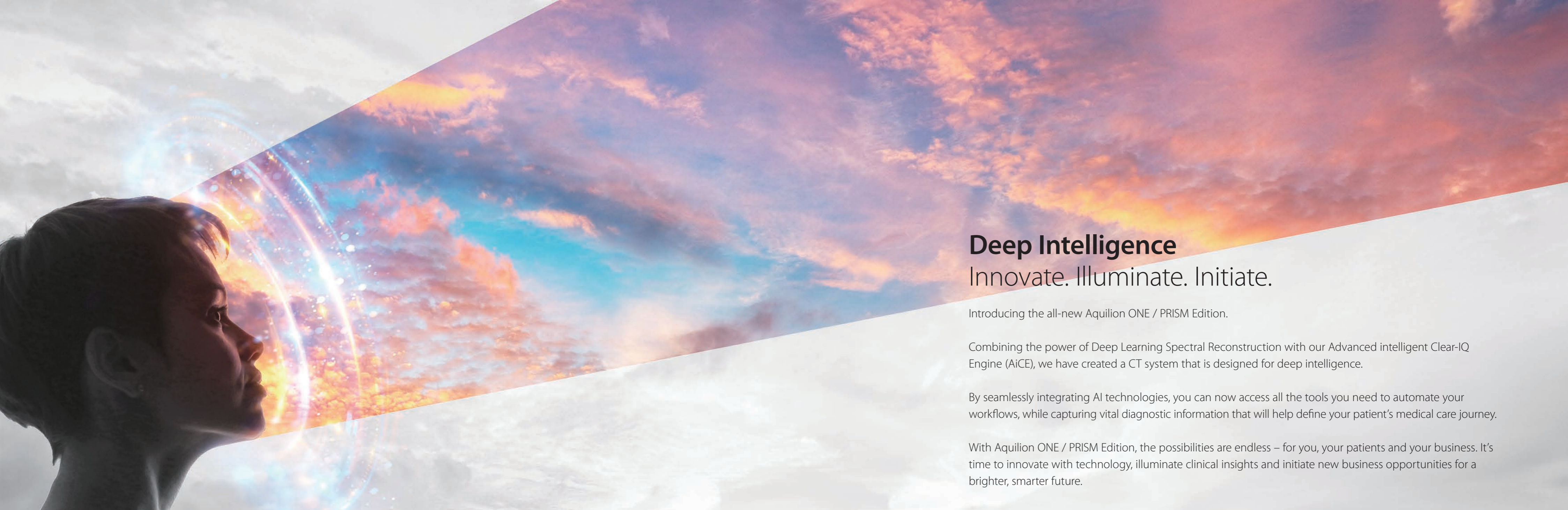

Deep Intelligence Innovate. Illuminate. Initiate.

Introducing the all-new Aquilion ONE / PRISM Edition.

Combining the power of Deep Learning Spectral Reconstruction with our Advanced intelligent Clear-IQ Engine (AiCE), we have created a CT system that is designed for deep intelligence.

By seamlessly integrating AI technologies, you can now access all the tools you need to automate your workflows, while capturing vital diagnostic information that will help define your patient's medical care journey.

With Aquilion ONE / PRISM Edition, the possibilities are endless – for you, your patients and your business. It's time to innovate with technology, illuminate clinical insights and initiate new business opportunities for a brighter, smarter future.



Innovate with technology

Take your clinical confidence to new heights with Canon Medical's AiCE and Deep Learning Spectral capabilities.

Welcome to the age of AI-assisted CT

Advanced intelligent Clear-IQ Engine (AiCE) – Deep Learning Reconstruction

AiCE is an innovative approach to CT reconstruction that uses Deep Learning innovation to match the spatial resolution and low-noise properties of advanced model-based iterative reconstructions.

Trained using high-quality image data, reconstructed with an advanced model-based iterative reconstruction (MBIR) algorithm, AiCE distinguishes true signal from noise to deliver exceptional scans without compromising on dose.

What's more, the Aquilion ONE / PRISM Edition is equipped with a dedicated high performance hardware that optimizes AiCE for 640 slices (with ConeXact double slice technology) to deliver the high performance expected from a flagship system.

- ✓ Low Noise
- ✓ Fine Image Texture
- ✓ Sharp High Contrast Resolution
- ✓ Clear Low Contrast Detectability

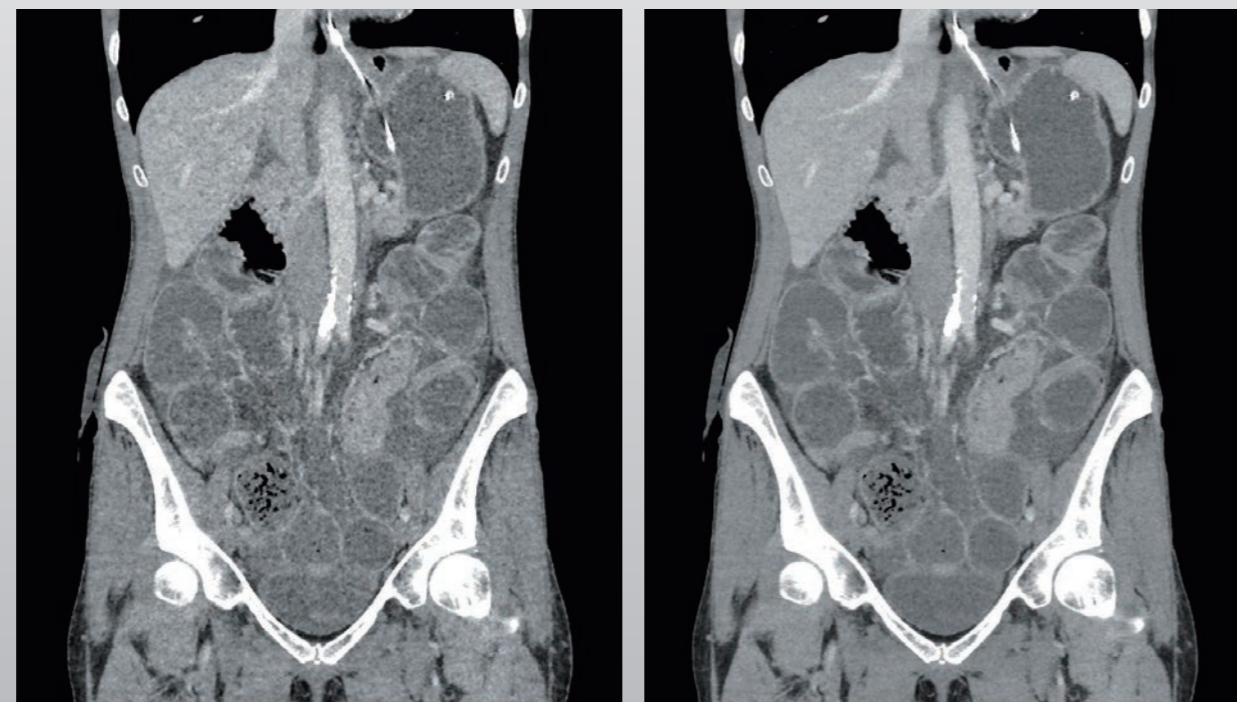

Hybrid IR

AiCE



Introducing Deep Learning Spectral imaging*

Canon Medical's Deep Learning Spectral CT system has been designed to take your imaging capabilities to a whole new level.

Not only does it harness the temporal benefits of rapid kV switching with patient-specific mA modulation, it combines them with a Deep Learning reconstruction that delivers excellent energy separation and low-noise properties.

What's more, its fully integrated end-to-end workflow is easy to use and can be conveniently incorporated into your routine protocols.

16 cm Volume Spectral scanner

Rapid kV switching

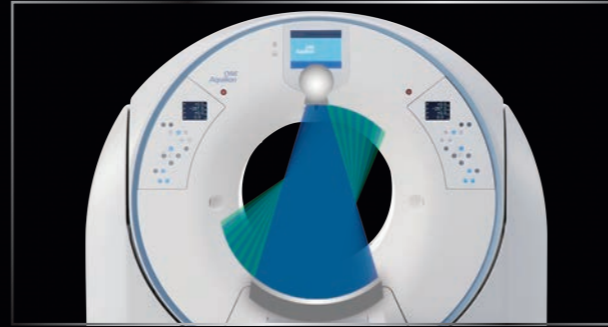

Auto Exposure Control

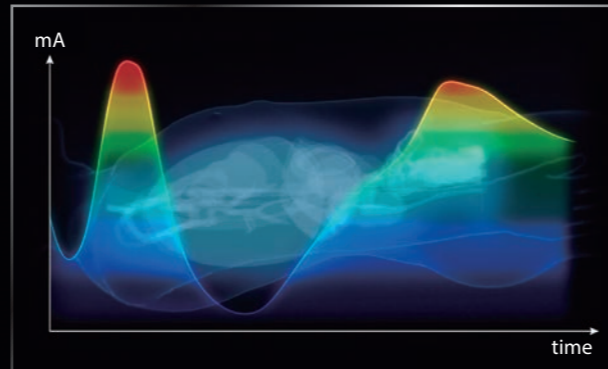

16 cm volume

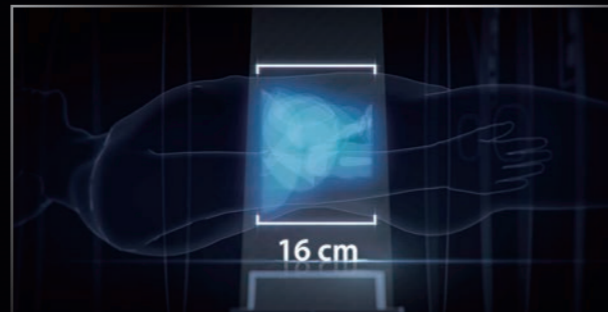

Spectral Deep Learning reconstruction



Full Spectral Transformation

The advantage of Deep Learning Spectral reconstruction is its ability to transform multi-energy raw data sets into two full high and low energy separated sinograms. This provides excellent energy separation for Spectral analysis with the high resolution and low noise properties you would expect from a routine diagnostic CT exam.

An extensive suite of Spectral analysis applications*

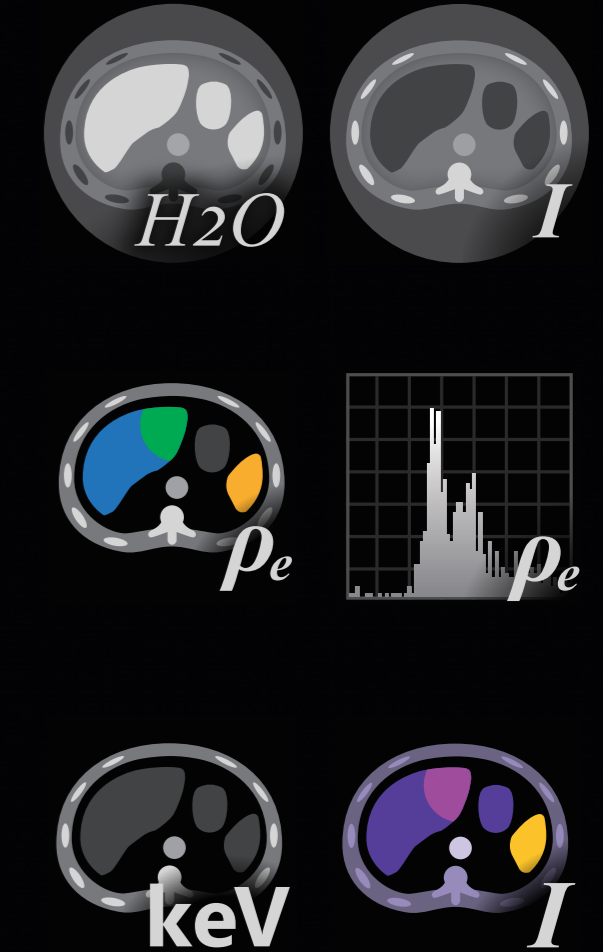

* In combination with Vitrea® Advanced Visualization

A smart, fast Spectral solution

Aquilion ONE / PRISM Edition with Deep Learning Spectral automatically reconstructs monochromatic images, material-specific reconstructions and iodine maps, to ensure you get the images you need consistently for your staff.

Images are delivered directly to your reading station for easy review, and with our range of new Vitrea™ applications, your team can analyze comprehensive Spectral data, including quantification and multi-layered images, for a detailed and confident diagnosis.

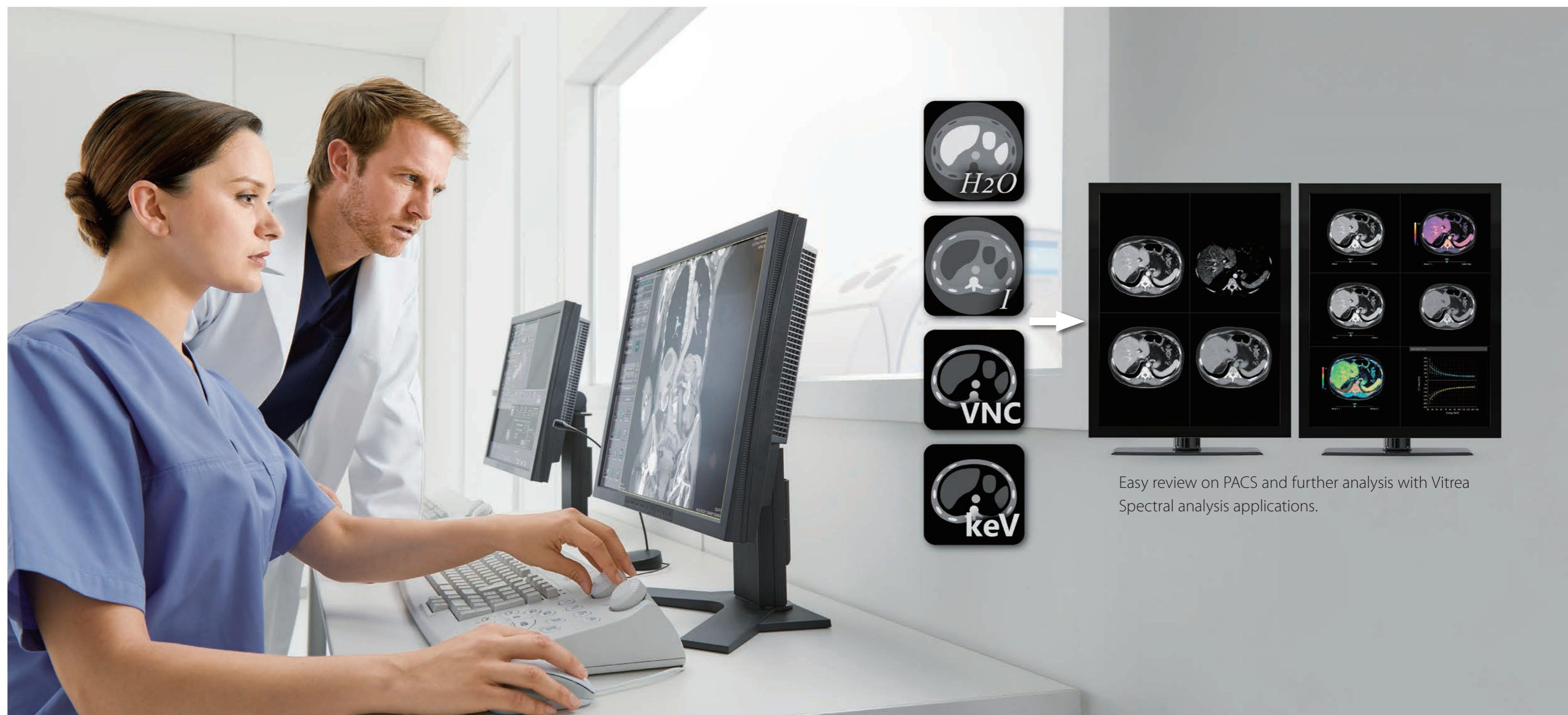

Easy review on PACS and further analysis with Vitrea Spectral analysis applications.



Illuminate clinical insights

Access all the information you need to make a clear, confident diagnosis that enables every patient to start the right treatment journey for them.

A single rotation is all it takes



Don't miss a beat with our cardiac CT solutions

The Aquilion ONE / PRISM Edition's 16 cm wide area detector significantly improves your ability to obtain high-quality images consistently across patients.

With just one rotation, you can acquire an entire heart in a fraction of a second – all with less dose and great z-axis uniformity.

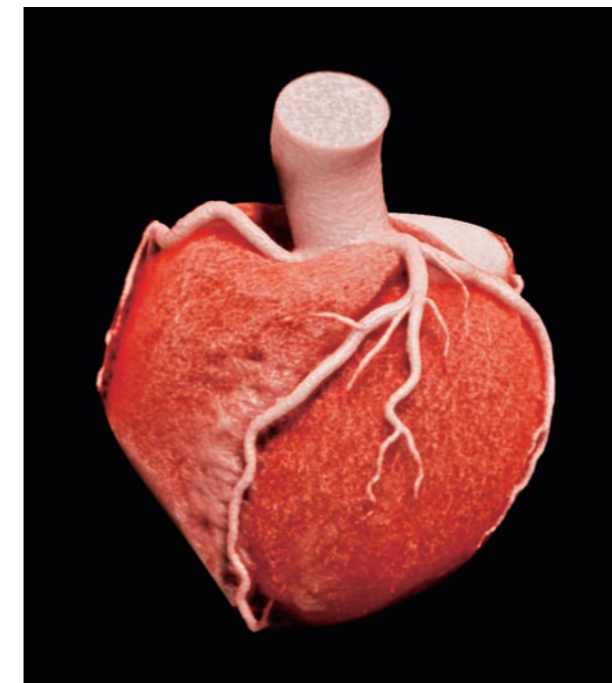

Technology that gets to the heart of the matter

Canon Medical's range of **SURE**Cardio technologies* has been designed to help you feel even more sure of your patient's diagnosis with robust, automated cardiac images.

SURECardio delivers clear, accurate images while enhancing workflow by automatically selecting the optimal scan and reconstruction parameters. This ensures high diagnostic image quality at a radiation dose tailored to each patient.

SUREExposure cardiac automatically selects the kV and mA based on your patient's size, as determined by the scanogram.

Real-Time Beat Control monitors the patient's heart rate in real-time and controls the exposure timing depending on the scan mode selected.

The Arrhythmia Detection Algorithm recognizes irregular cardiac rhythms and controls scan exposure in real-time to ensure a diagnostic study. This may help reduce both the amount of IV contrast required and the radiation dose by minimizing the need for a repeat examination.

phaseXact is our fully automated phase selection software that automatically determines the optimal cardiac phase for motion-free reconstruction. Phase selection is performed in the raw data domain and requires no operator intervention.

ECG Gated Single Energy Metal Artifact Reduction (SEMAR): SEMAR technology improves the visualization of cardiac devices such as pacemaker leads and the adjacent soft tissues for clearer and more confident diagnosis.

When time is brain, every second counts

The Aquilion ONE / PRISM Edition provides a comprehensive stroke evaluation platform that offers whole brain perfusion imaging and 4D digital subtraction angiography of the intracranial circulation in just one minute.

After the scan, within the time it takes to get a patient out of the CT room, Canon Medical's 4D brain perfusion software evaluates flow and perfusion defects ensuring you have all the diagnostic information you need to make the appropriate treatment decision in under five minutes.

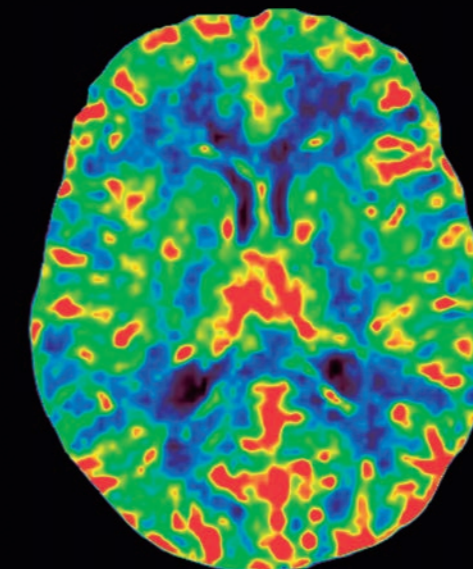
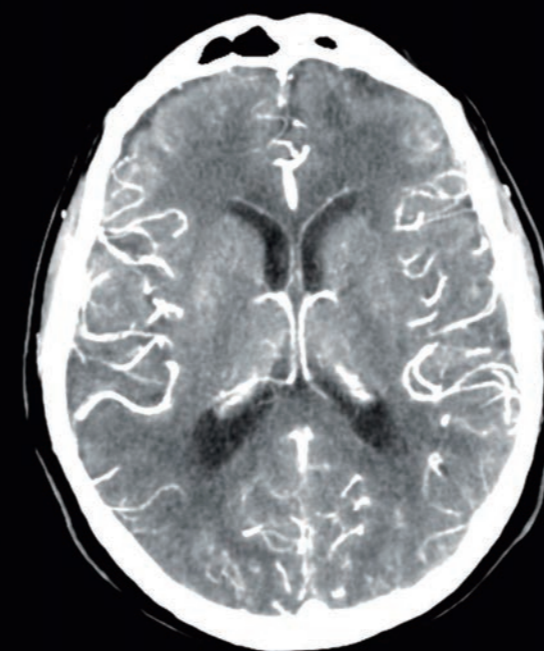

CBV

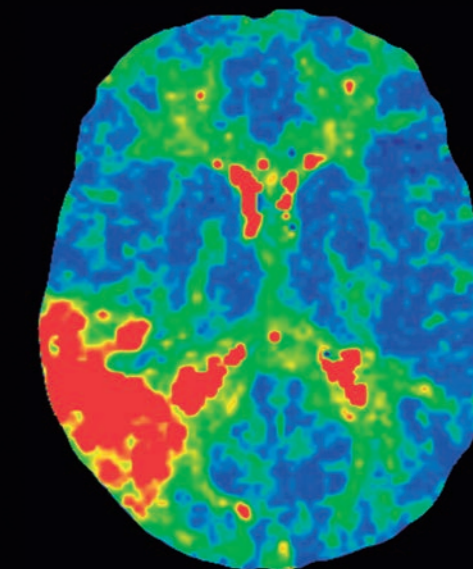

TTP

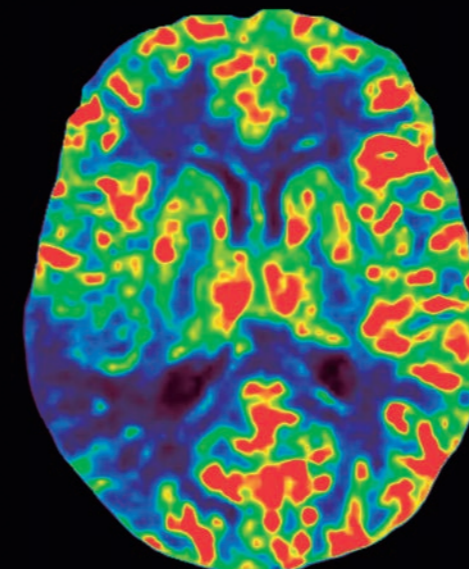

CBF

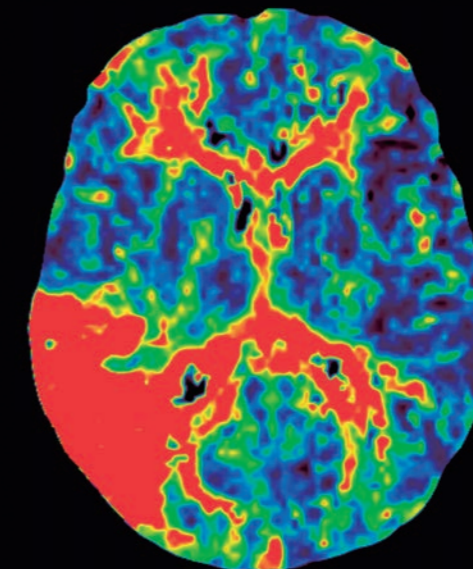

MTT

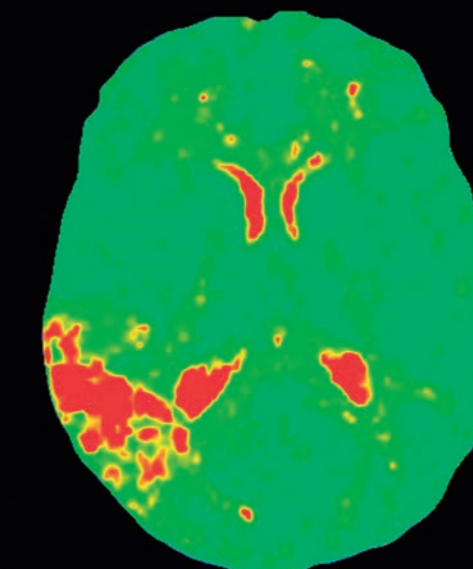

Delay

Simple and streamlined CT Fluoroscopy*

Conduct faster, more focussed interventional procedures with our new CTF interface that enables one-handed operation thanks to ergonomically designed controls and a versatile touchscreen tablet.

Plus, with Canon Medical's iterative reconstruction you now have real-time access to the high-quality, low-dose images you need to optimize the speed and safety of all your interventional procedures.



Speed, quality, low dose – you can have it all

Variable Helical Pitch (vHP) 3 phase* allows three scans to be performed in a single acquisition, seamlessly transitioning between scan parameters optimized for each body region.

vHP 3 phase has potential for less contrast media and lower radiation dose by providing the flexibility to seamlessly transition:

- Between ECG Gating on and off during a cardiac scan
- Between dose and image quality during a CAP scan
- Between fast and detailed pitch during a trauma scan

Additionally, AiCE provides high-fidelity images through the entire scan range, overcoming the challenges of image reconstruction through the transition zones. With three scans in one, the single series reconstruction enables several studies to be interpreted simultaneously for faster reading.

vHP 3 phase – Optimal Gating Cardiovascular scan

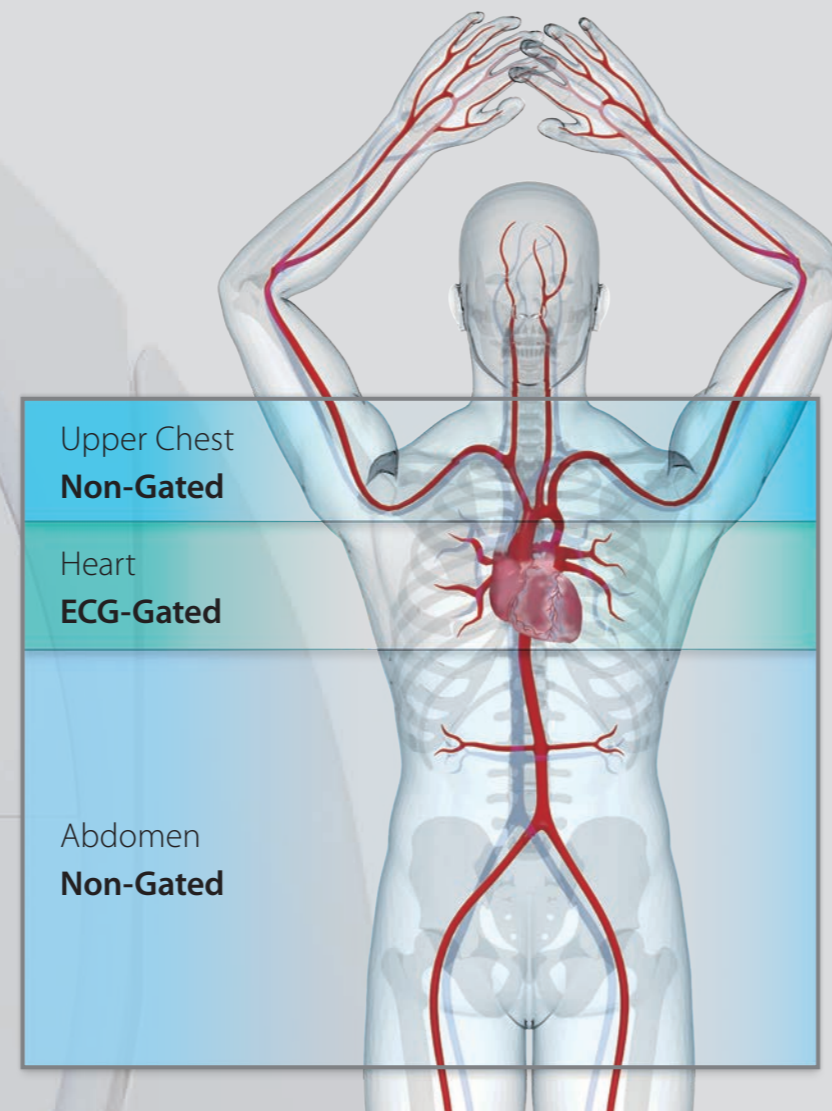

vHP 3 phase – Optimal Exposure Chest, Abdomen, Pelvis scan

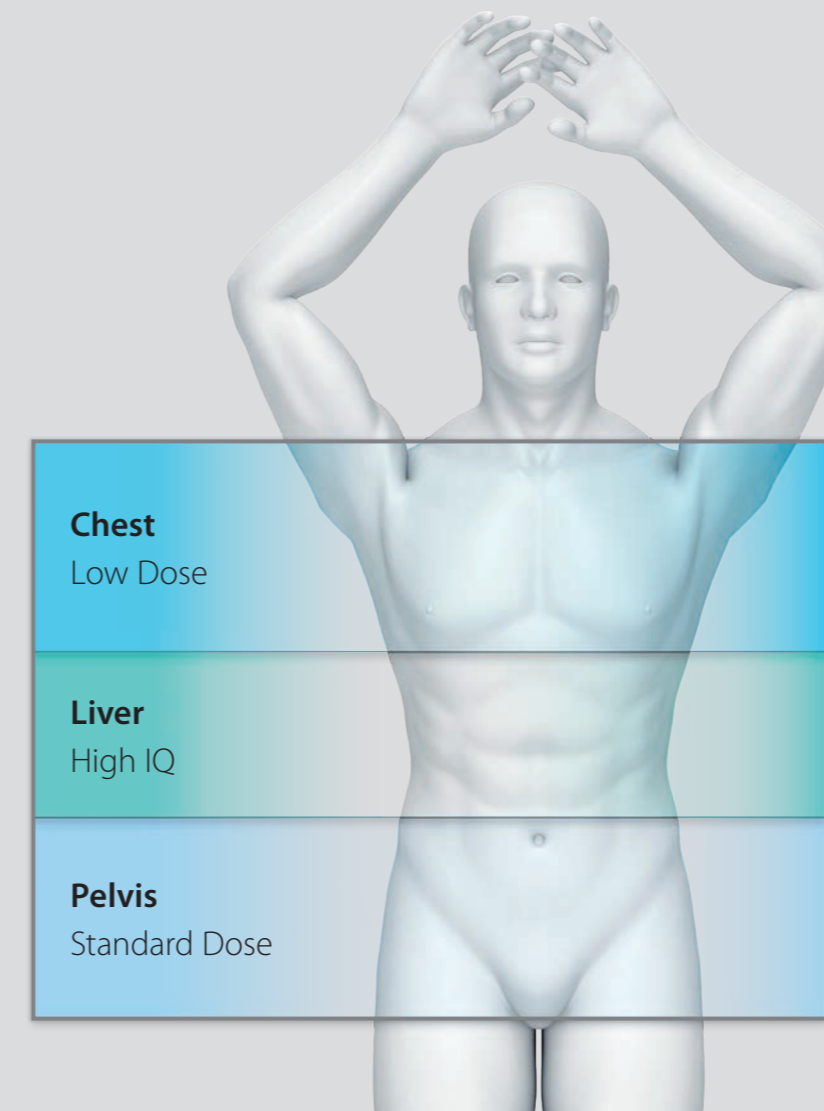

vHP 3 phase – Optimal Speed Trauma scan

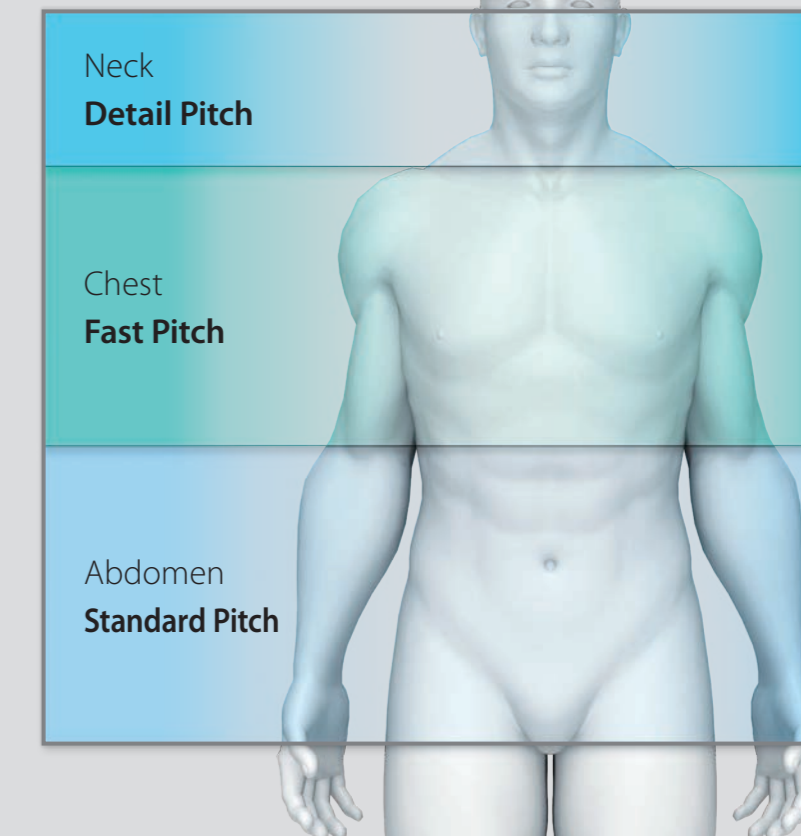

Expand your spectrum with our latest healthcare IT solutions

Vitrea Advanced Visualization*

Review Spectral data quickly and easily with a range of applications that simplify your workflow and provide clinically relevant features and outputs for every patient.

- ✓ Create effective monochromatic images for 101 energy levels ranging from 35 keV to 135 keV.
- ✓ View quantitative color-coded iodine distribution maps that show the iodine uptake in anatomical structures.
- ✓ Characterize and differentiate tissue with detailed Z and Electron density information at your fingertips.
- ✓ Differentiate between uric acid and non-uric acid urinary stones to help make better-informed treatment decisions.
- ✓ Visualize and quantify the presence of monosodium urate in anatomical structures.



Monochromatic Images



Iodine Map



VNC

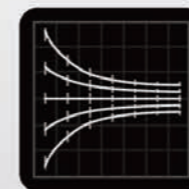

Spectral Curves

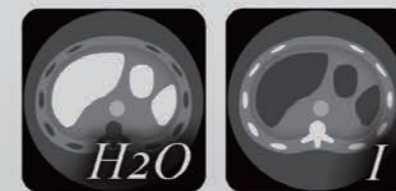

Basis Material Analysis

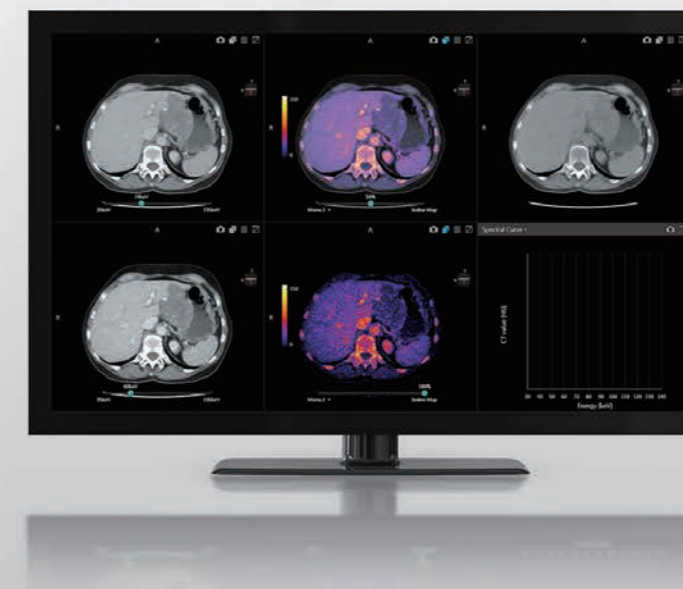

Composition Analysis



Stone Analysis

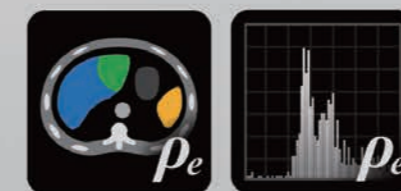

Electron Density Images



Effective Z Images

* Vitrea is available as an option.

The new standard in advanced visualization

Global Illumination Rendering

Discover a new standard of visualization with Canon Medical's smart 4D rendering technique that helps you get a more photorealistic view of human anatomy.

It's simple-to-use and integrates seamlessly into your Vitrea workflows for easy sharing and collaboration across your patient's care team.

- ✓ Real-time image manipulation enables you to quickly segment and edit anatomy without disrupting your clinical workflow.
- ✓ Incredible photorealistic images can enhance your presentations and help you showcase your hospital's work to the rest of the world.
- ✓ Compared with traditional volume rendering, Global Illumination provides exquisite detail and depth perception for an improved understanding of image content.
- ✓ Global Illumination is an invaluable tool for clinicians who rely on imaging technology, particularly oncologists, surgeons, and forensics.

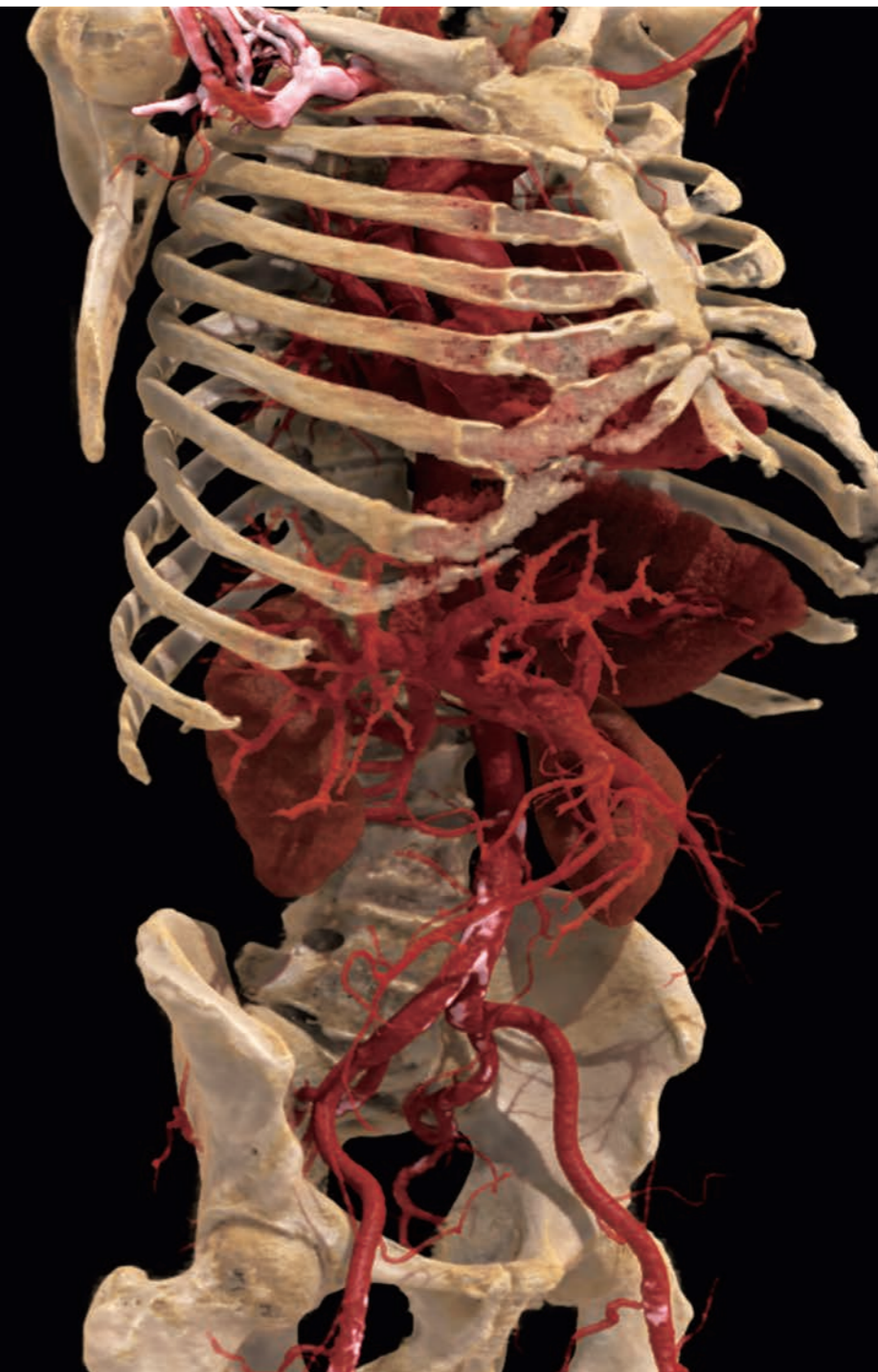

Clinical workflow that works for you

Aquilion ONE / PRISM Edition comes with a range of smart features and functions that make every stage of the scan process time-efficient and straightforward.

Now, whether you're setting up a patient, conducting the scan or reviewing results, you'll be able to rely on fast, flexible, and automated technologies that make life easier for everyone.

Before the scan

Make sure your patients are set up for a picture-perfect image.

Area finder*
SUREPosition technology
Unique flared gantry



* Option



During the scan

Optimized dose and easy injection make the whole process safer.

SUREkV
SUREExposure
CAN4 injector

After the scan

Boost your efficiency with smart tools that tailor the image to your needs.

AiCE quality
SEMAR
Iodine maps
Spectral Analysis
Perfusion and DSA





Initiate business opportunities

Stand out with a CT solution that optimizes your workflow, improves the patient experience, and potentially helps you save time and money every step of the way.

Safer and simpler for everyone

Without a doubt, scanning lots of patients throughout the day takes a lot of effort from your team. But with Aquilion ONE / PRISM Edition, you can now expedite the process with smart technology that does the heavy lifting for you.

Lateral slide*

Reduce the risk of injury to your patients or technologists with a tech assisted lateral slide that mechanically moves the patient left or right to the correct position at the touch of a button.

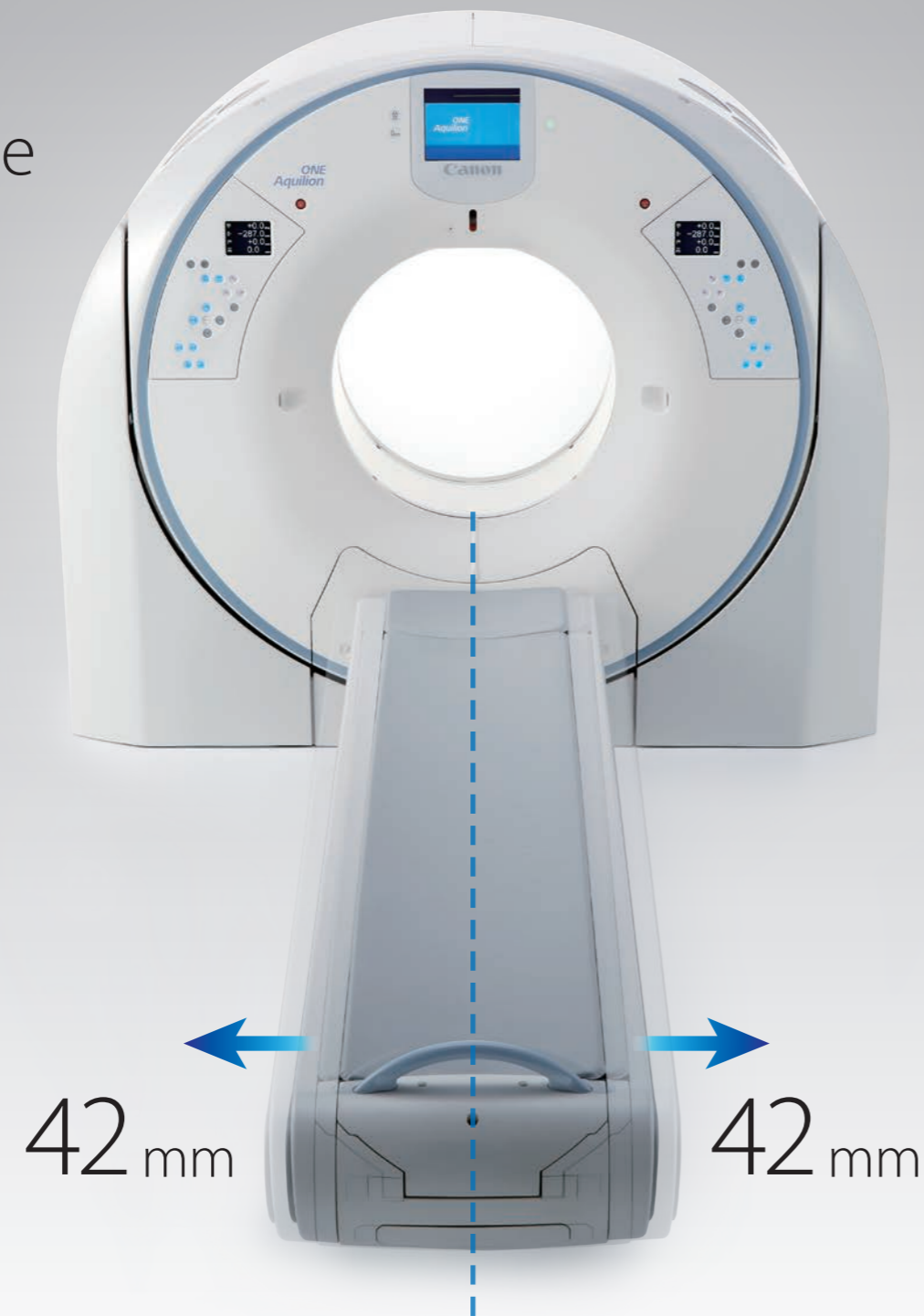

Quick and convenient access

The Aquilion ONE / PRISM Edition's shorter flared gantry gives you easy access from the front or rear of the tunnel, making it the ideal choice for treating patients who have experienced trauma, or are undergoing interventional procedures.

A CT exam with the ease of plain film X-ray

Simple scans covering 16 cm or less can now be done without the complexity of traditional scan planning. With Aquilion ONE / PRISM Edition, you can now set the field of view and scan range directly at the gantry – bypassing the usual scanogram and saving valuable time when it matters most.



Designed to fit most clinical environments

With just 19m²* installation space requirement, Aquilion ONE / PRISM Edition is one of the smallest and most space-efficient Spectral CT systems in the market. Installation is easy, and it can fit into most standard CT rooms.



Installation Space



Power Capacity

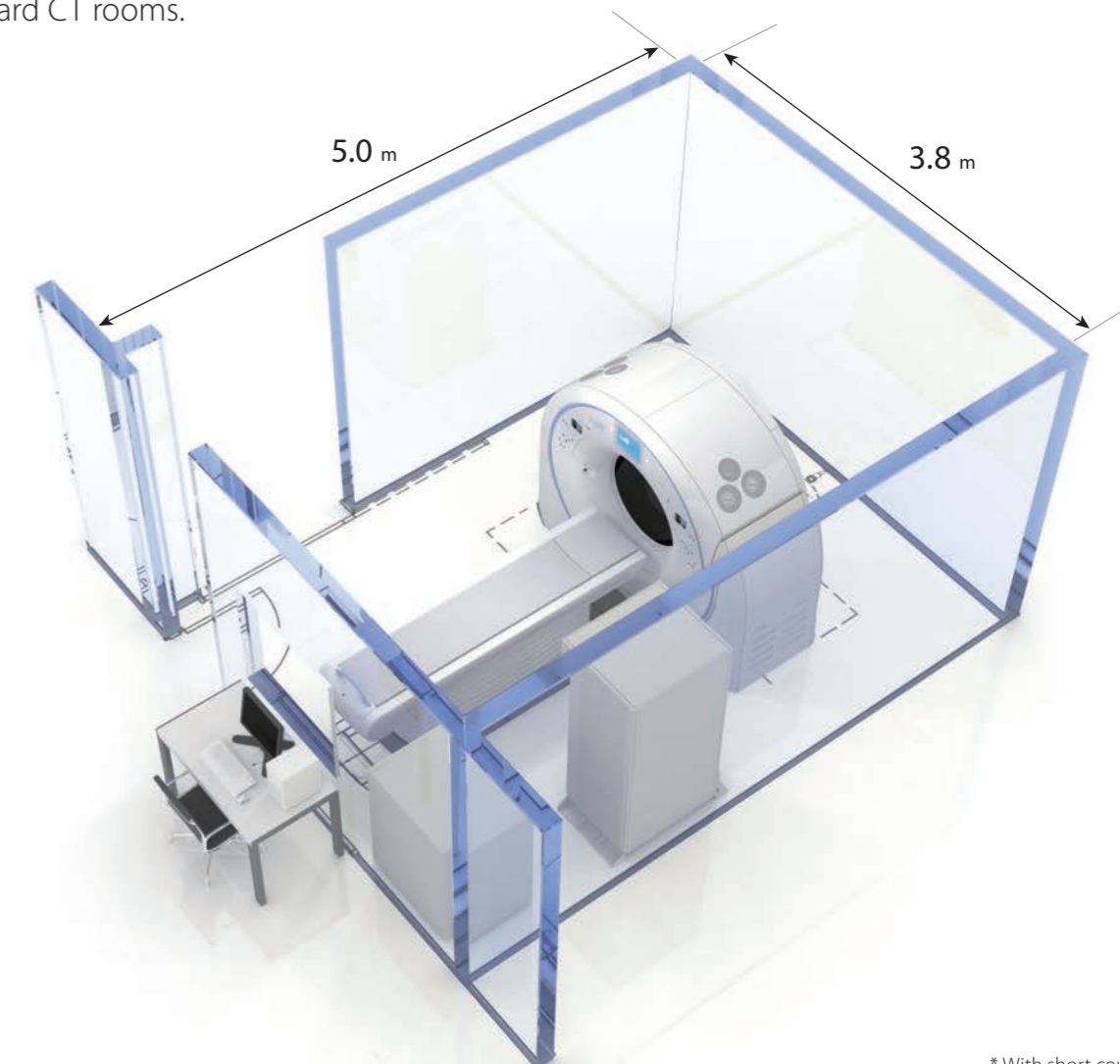

* With short couch

Tailor it to your business

Canon Medical's workflow solutions are dynamic and scalable enough to meet a whole range of needs – whether you're a smaller clinic or well-established enterprise.

Our IT solutions are modular, so you can pick and choose the configurations that work for you, and you can even open them up to remote users, so you're not confined to a single setting.

Scalable Vitrea solutions to grow with the needs of your organization



Control Room



Reading Room



Hospital-wide

Neuro

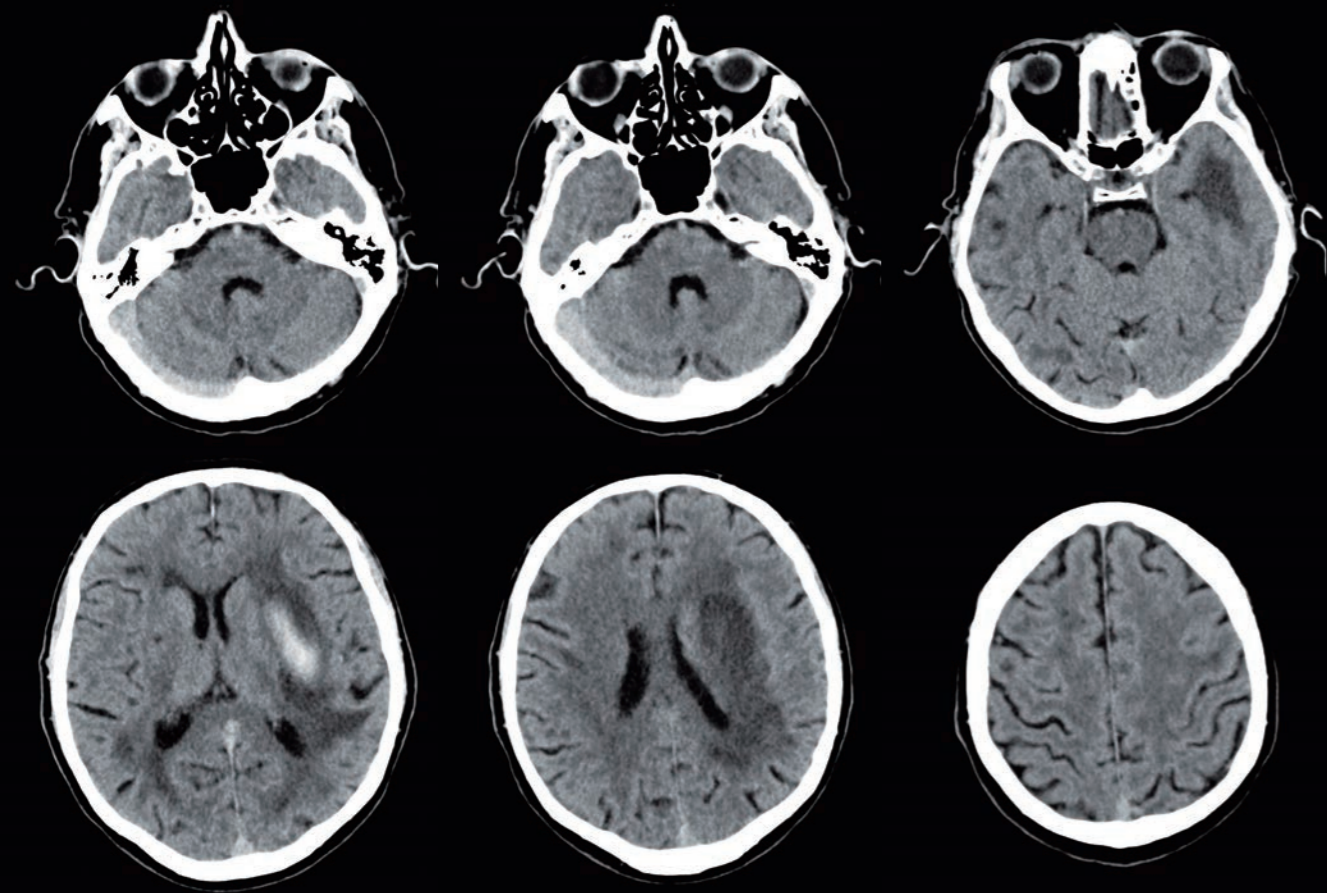

Excellent gray/white differentiation and fine grain size with AiCE.

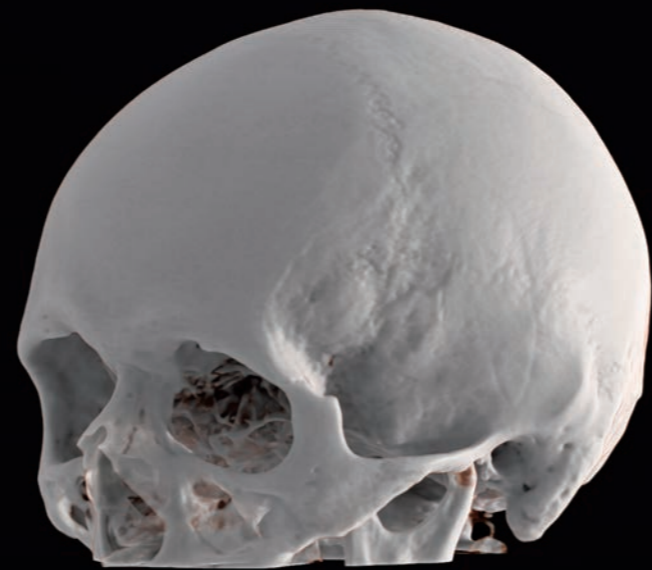

Global Illumination rendering for photorealistic view

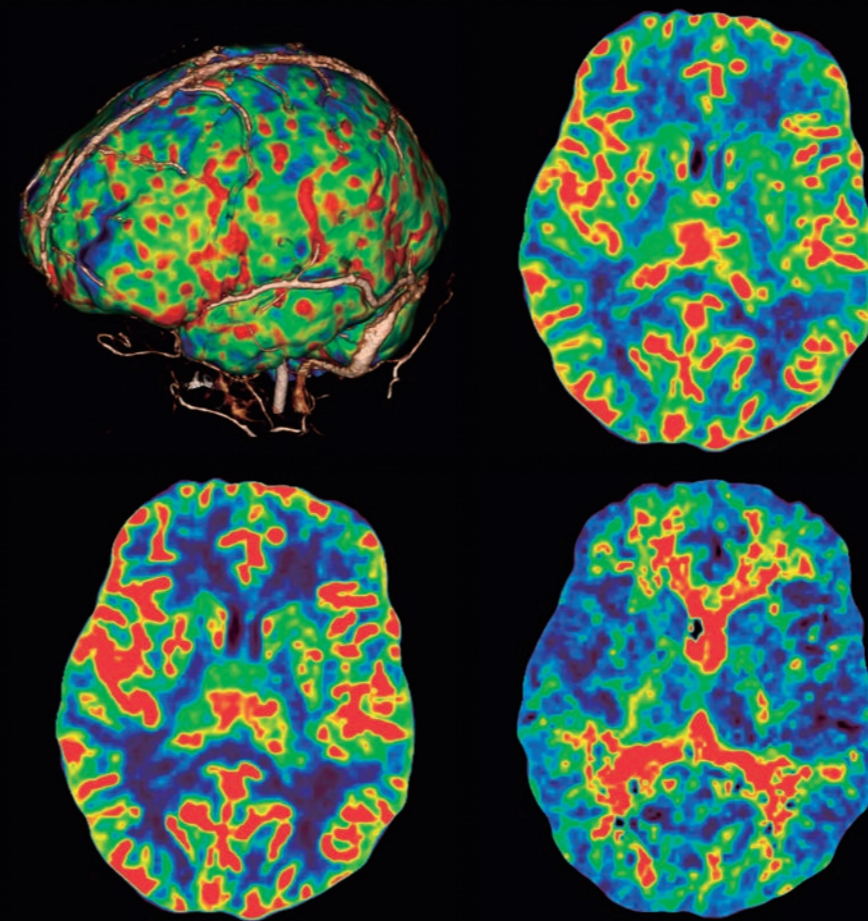

Whole Brain perfusion with AiCE and Bayesian algorithm

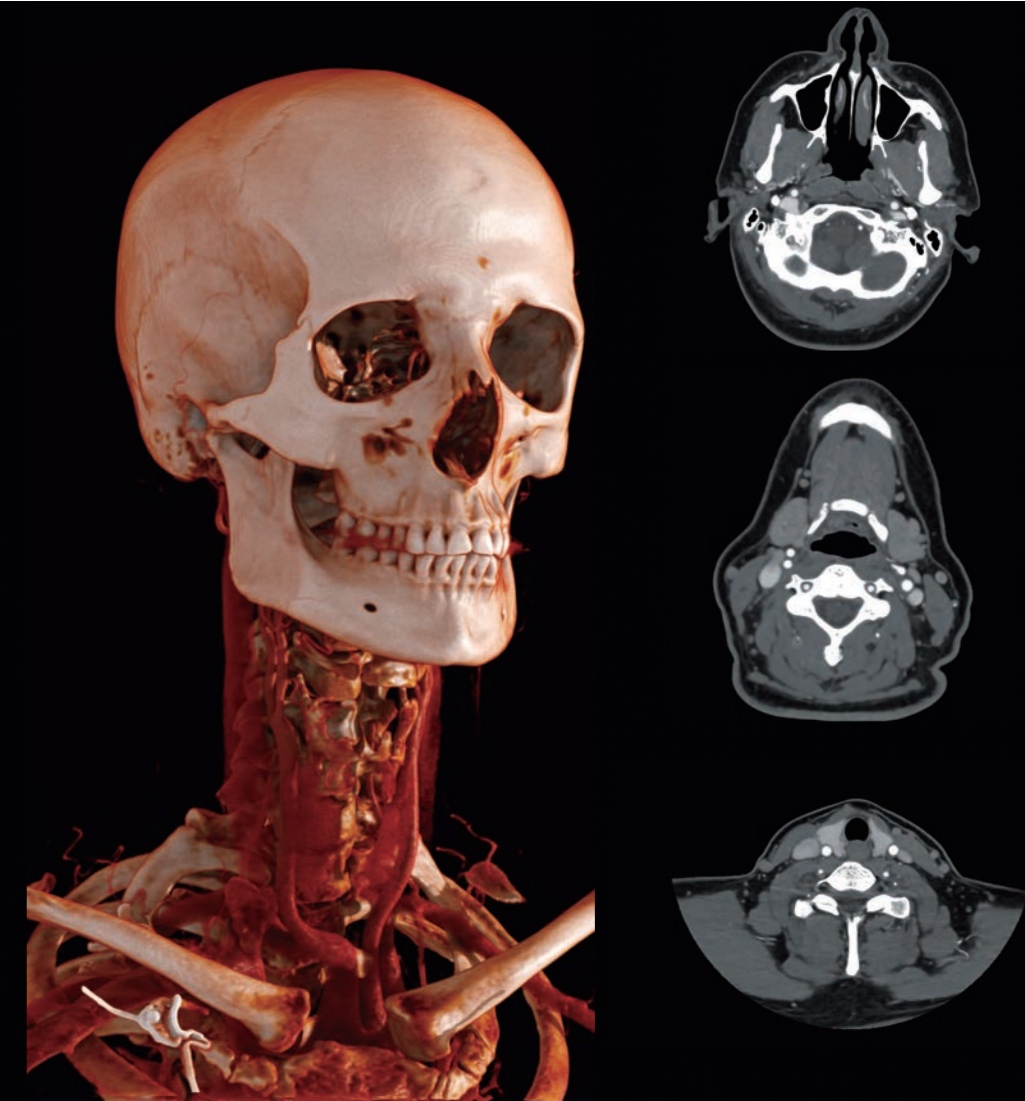

Carotid CTA reconstructed with AiCE. Superb Global Illumination rendering and noise free axial images.

Cardiac

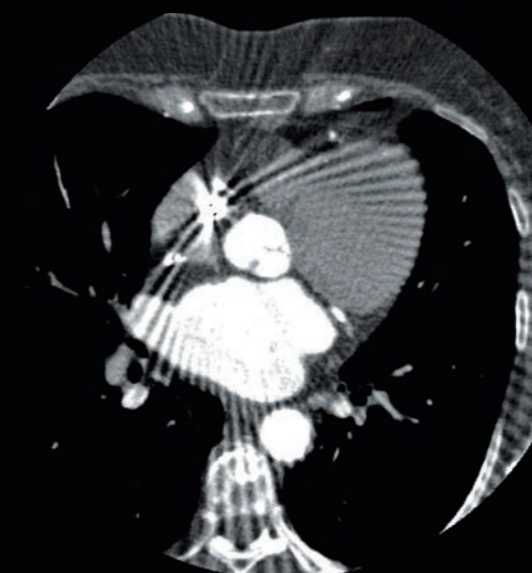
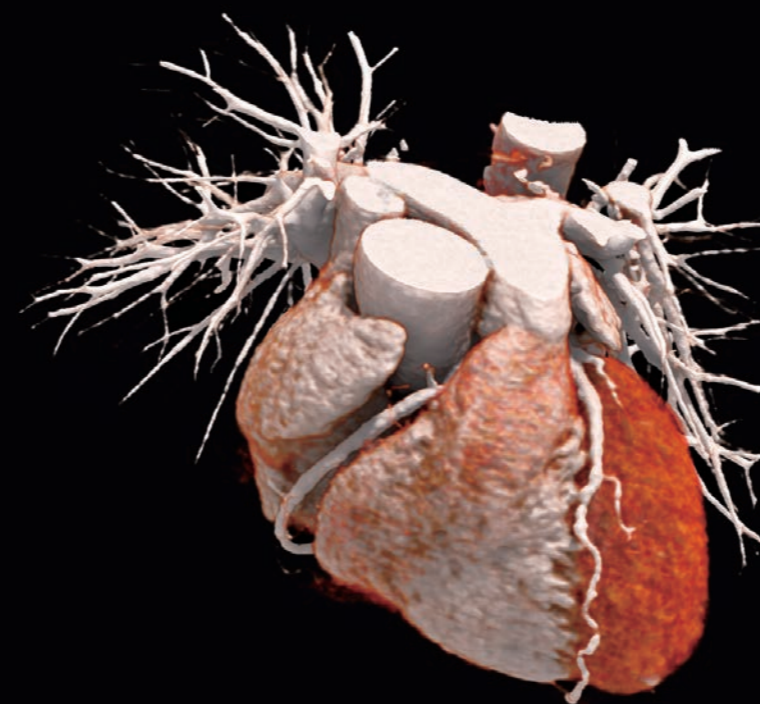
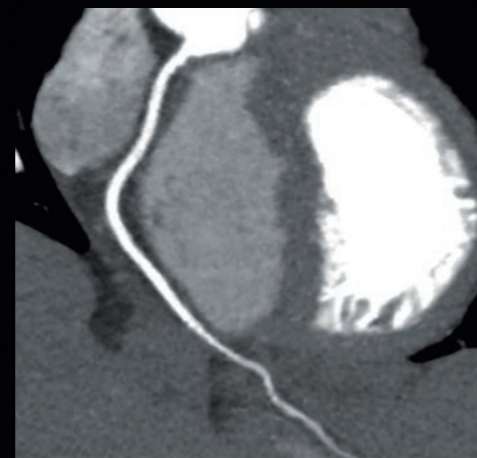
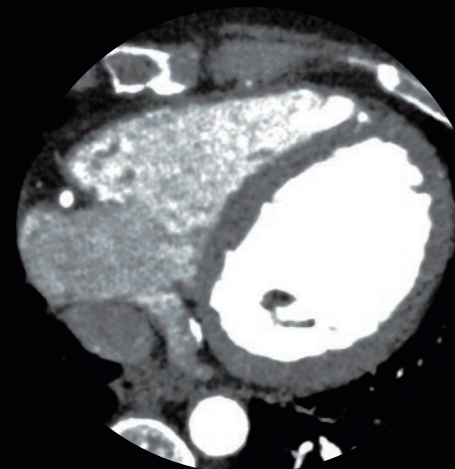

AiDR 3D

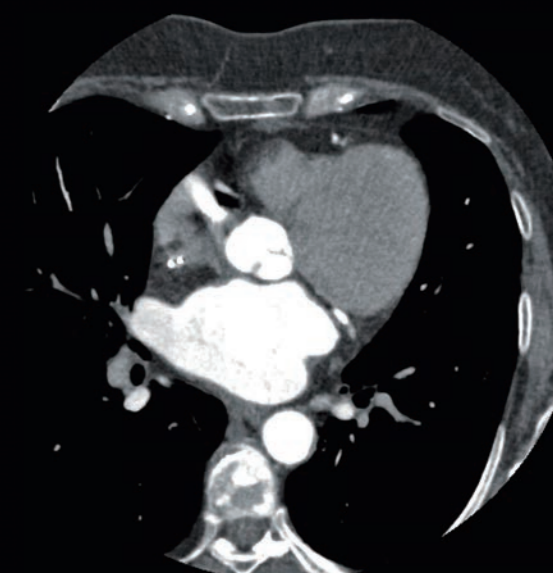

AiCE with SEMAR

Low Dose Cardiac with AiCE, 0.8 mSv.

Global Illumination Rendering or photorealistic view

Metal artifact reduction from a defibrillator lead with SEMAR

Chest

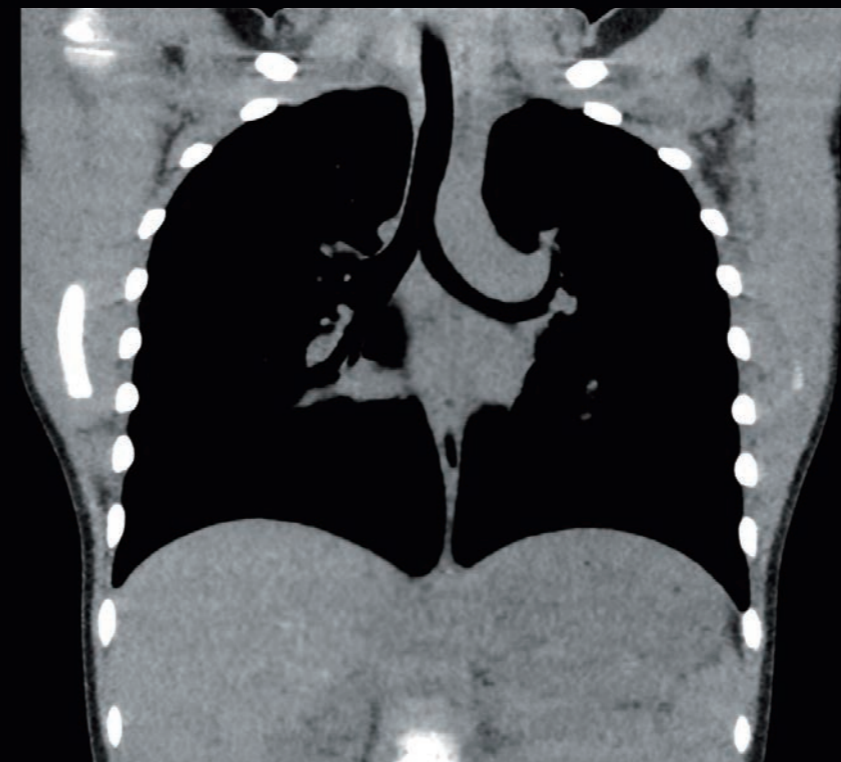
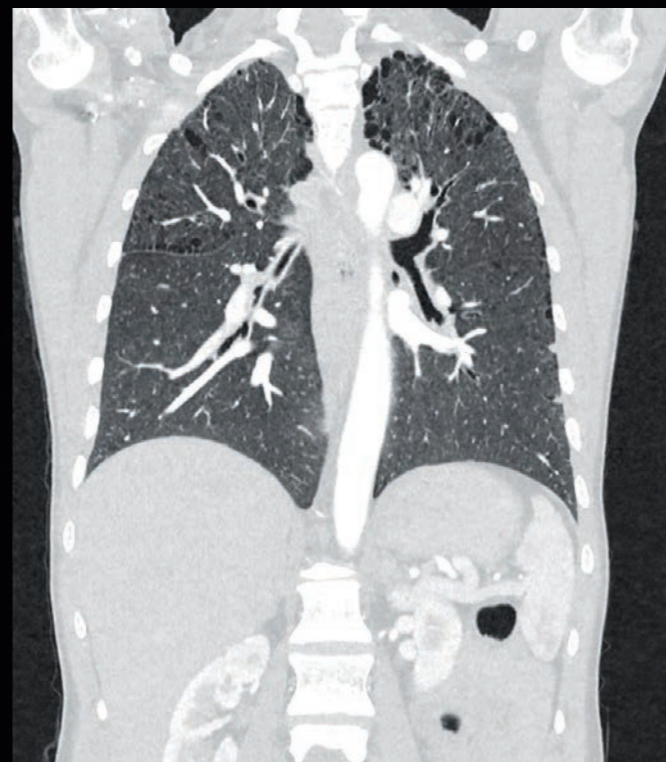

Routine low dose chest imaging with AiCE, 0.6 mSv.

Ultra low dose chest scan on a 7 year old child with DLP, 2.7 mGy-cm.

Body

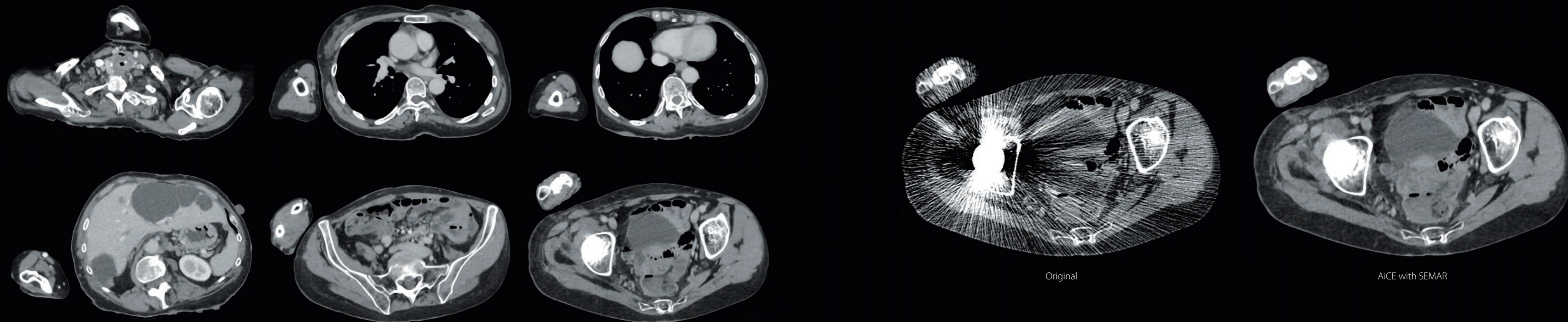

Excellent low noise images of the chest and abdomen with AiCE even with the arm down by the patient's side.

Body

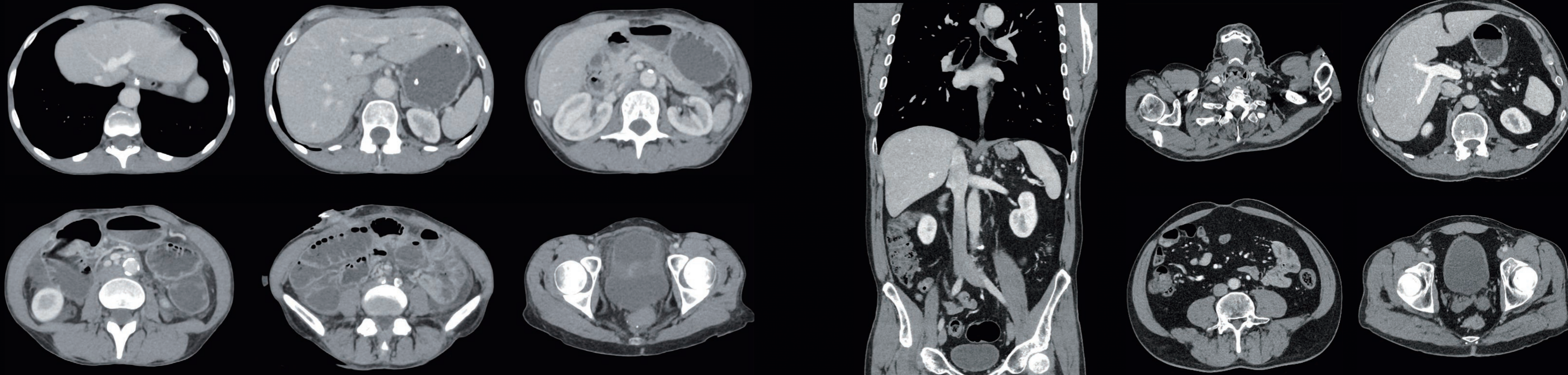

Low dose scan of the abdomen with AiCE, 1 mSv.

Low noise images of the chest and abdomen with 0.5 mm slices for improved visualization of small structures with AiCE.

Musculoskeletal

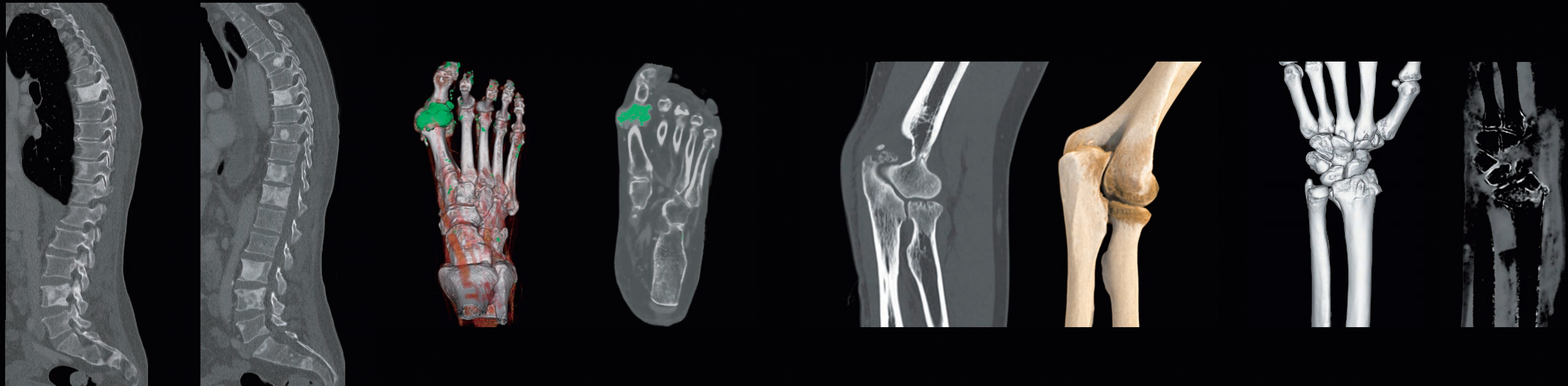

Spectral Bone, excellent sharpness and details of spine, 2.3 mSv.

Material decomposition from Spectral can identify MSU deposits in the body

AiCE Bone, excellent sharpness and detail

Spectral CT of the wrist for evaluation of fracture post traumatic injury

Spectral

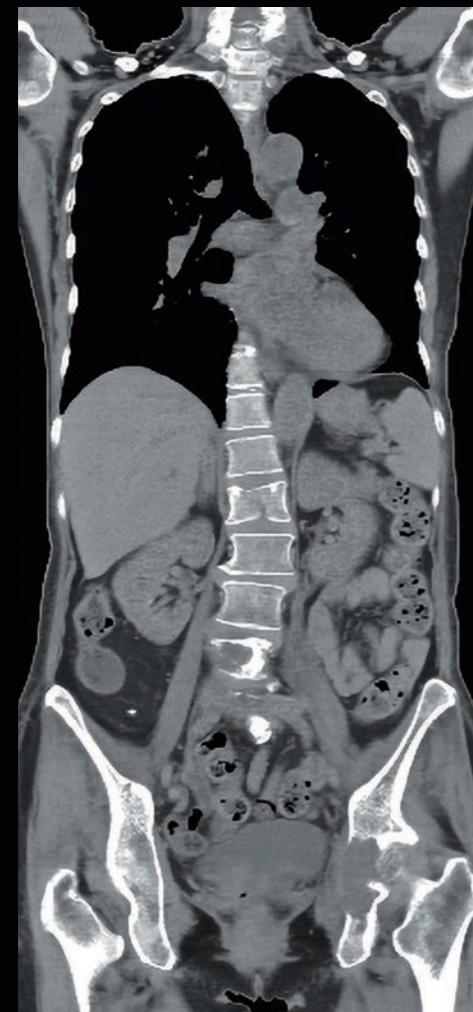

Virtual Non Contrast

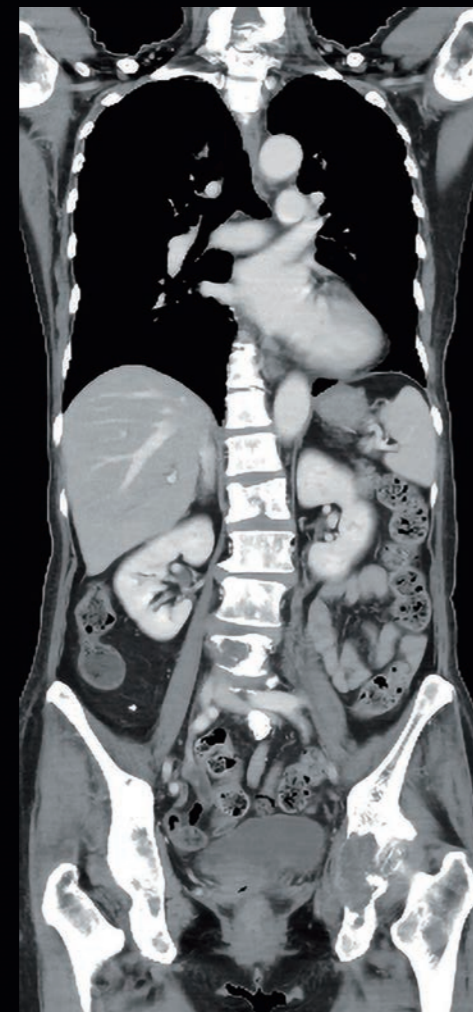

Monochromatic

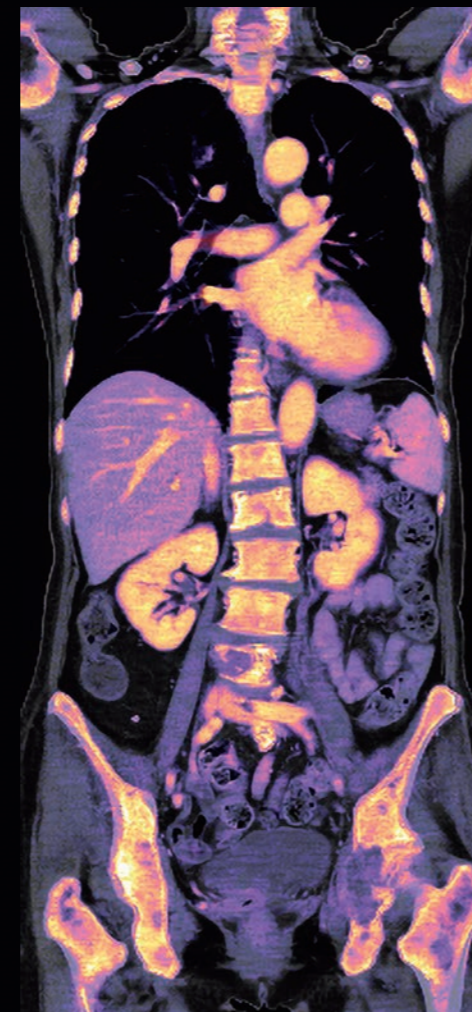

Iodine map with fusion

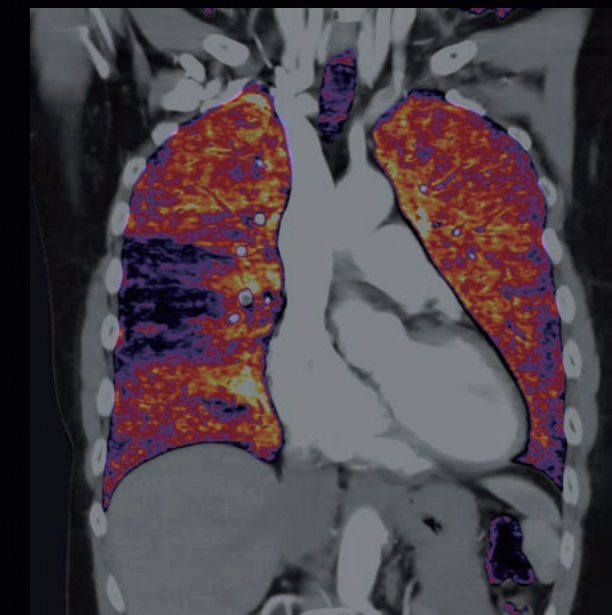
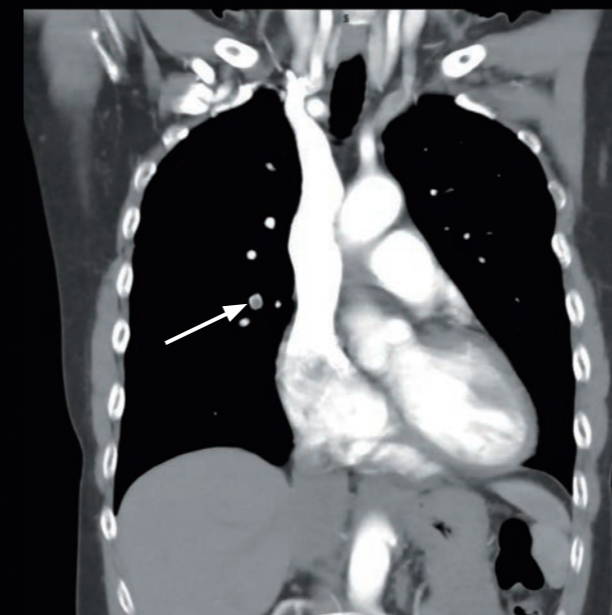

70 keV virtual Monochromatic images with iodine mapping



Main specifications		
Detector		PUREVISION detector
		320 rows, 0.5 mm
Gantry	Rotation time	Min. 0.275 s ^{*1} , 0.35 s
	Bore size	78 cm
	Bore depth	38.7 cm
	Tilt	± 30°
Patient couch	Load	220 / 315 kg, 694 lbs ^{*2}
	Max. scan range	150-200 cm ^{*2}
Reconstruction speed	Volume	5 s
	Helical	Max. 80 fps
Reconstruction	Iterative reconstruction	AIDR ^{*3} 3D Enhanced
	Deep learning reconstruction	AiCE ^{*1}
Installation	Power capacity	125 kVA ^{*1} , 100 kVA
	Space	Min. 19 m ² (short couch)

^{*1} Option
^{*2} Depending on system configuration
^{*3} Adaptive Iterative Dose Reduction

Clinical results may vary due to clinical settings, patient preparation and other factors.
 Due to local regulatory processes, some of the products included in the brochure may not be available in each country.
 Please contact your sales representative for the most current information.



Работайте с лучшими,
всё остальное компромисс!

8 (800) 775-10-98

medliga.ru